

ENGLISH

DIGORA[®] Optime DXR-50 001

Digital intraoral imaging plate system

User's Manual

Document no. 204253 rev. 3 (2010-03)

DIGORA® Optime DXR-50 001

Digital intraoral imaging plate system

User's Manual



This unit is marked according to the Medical Device Directive
93/42/EEC (if the unit contains the CE mark)

Document number 204253 rev. 3 (2010-03)

Original approved English language version

Manufactured by SOREDEX
P.O. BOX 148
FIN-04301 TUUSULA,
FINLAND
Tel. +358 (0)10 270 2000
Fax. + 358 9 701 5261

Soredex endeavours to produce product documentation that is accurate and up to date. However, our policy of continual product development may result in changes to products that are not reflected in the product documentation. Therefore, this document should not be regarded as an infallible guide to current product specifications. Soredex maintains the right to make changes and alterations without prior notice.

Contents

1. The DIGORA® Optime	1
1.1 Introduction	1
1.2 System installation	2
Positioning the unit	2
Positioning the PC	3
Other devices	3
2. Intraoral imaging plate unit	4
2.1 Main parts and controls	4
2.2 Accessories	5
2.2 Display symbols and what they mean	7
3 Using the system	11
3.1 General	11
3.2 Preparing the system	11
3.3 Preparing an IP for exposure	13
3.4 Imaging plate holders	15
3.5 Taking an exposure	16
3.6 Reading an imaging plate	18
Single user configuration	18
Multiconnect configuration	21
3.7 Removing IPs from the plate collector	22
3.8 Standby mode	22
3.9 Retrieve last image	23
3.10 Shutting down the unit	24
3.11 IP erasing mode (Initial erasing of the IPs)	24
3.12 Taking an occlusal projection image	26
3.13 Errors and warnings	27

4. Handling and care of imaging plates.....	28
4.1 General	28
4.2 Handling	28
4.3 Cleaning	29
4.4 Storage	30
4.5 Replacement	30
4.5 Disposal	30
5. Unit care and maintenance	31
5.1 Cleaning the unit	31
5.2 Disinfecting the unit	31
5.3 Maintenance	32
5.4 Repair	32
5.5 Disposal	32
6. Symbols that appear on or in the unit.....	33
7. Warnings and precautions	34
Appendix A. Technical Specifications	A - 1
Appendix B. Installation and setup	B -1
B1 System installation	B -1
Positioning the unit	B -1
Positioning the PC(s) (not supplied)	B -1
Other devices	B -2
B2 Connecting the unit to a PC / LAN.....	B -2
Direct connection method (uses the unit s/n)	B -2
IP method (using the unit IP address)	B -5

B3 Setup options	B -7
B3.1 Scanner	B -7
Status	B -8
Image Scanning	B -8
Using the dental chart	B -8
Resolution	B -9
Image Processing	B -9
Last image	B -9
Scanner Unit Serial number	B -9
B3.2 Workflow	B -10
Readout start	B -11
Touchless operation	B -12
Plate eject mode	B -12
B3.3 Power options	B -13
Power options	B -13
B3.4 Hygiene	B -14
Automatic UV disinfection	B -14
Manual UV disinfection control	B -15
B3.5 Occusal	B -16
Occlusal / Size 3	B -16
B4 Troubleshooting	B -17

1. The DIGORA® Optime

1.1 Introduction

This manual describes how to use the DIGORA® Optime digital imaging plate unit (the unit) which is part of the digital intraoral imaging plate system (the system). The complete system comprises the following:

- the DIGORA® Optime digital imaging plate unit (the unit).
- SOREDEX dental Imaging Plates (IPs), protective covers, hygiene bags and other related imaging plate accessories.
- A PC (not supplied) in which suitable dental imaging software.
- A local area network (LAN) cable (not supplied) will be required if the system is to be used in a network.

The unit is a laser scanning device designed to automatically read reusable SOREDEX dental intraoral imaging plate sizes 0, 1, 2, and 3. The **Comfort Occlusal™ 4C kit** also allows two size 3 imaging plates to be used to take an occlusal projection image. After reading the images can be viewed on the PC using the dental imaging software.

The unit can either be connection directly to the PC or to network via the LAN cable.

The unit can be set up to work with a single PC, the **single user** configuration, or with several PCs, the **multiconnect** (multiple user) configuration. With the multiconnect configuration up to eight PCs can be used, one at a time, with the unit. This manual describes how to use both configurations.

NOTES:

Only personnel trained and authorized by the manufacturer of the unit are allowed to install and configure the unit.

Only use the imaging plates, protective covers and hygiene bags supplied by the manufacturer of the unit.

Please read the section **7. Warnings and precautions** before using the unit.

1.2 System installation

Positioning the unit

Do not position the unit in direct sunlight or near bright light. Sunlight or bright light must not be allowed to shine directly on the unit door into which the IPs are inserted.

Position the unit on a stable flat surface so that vibrations will not degrade the image quality. The unit can also be attached to a wall, under or on a shelf with the optional mounting kit.

The unit must not be positioned so that it is touching other equipment. It must not be placed on top of or under other equipment.

The unit can be positioned within the environment in which the patient is examined and treated (patient environment).

Positioning the PC

The PC connected to the unit should not be used in the patient environment.

The minimum horizontal distance between the patient and the PC is 1.5 m (4.5 ft).

The minimum vertical distance between the patient and the PC is 2.5 m (6.5 ft).

Other devices

DO NOT connect any other devices to the unit or the PC connected to the unit that are:

- not part of the supplied system
- not supplied by the manufacturer of the unit
- not recommended by the manufacturer of the unit.

2. Intraoral imaging plate unit

2.1 Main parts and controls

Power on / off key and status light:

- - green = on
- - flashing = entering the standby mode
- - yellow = in the standby mode

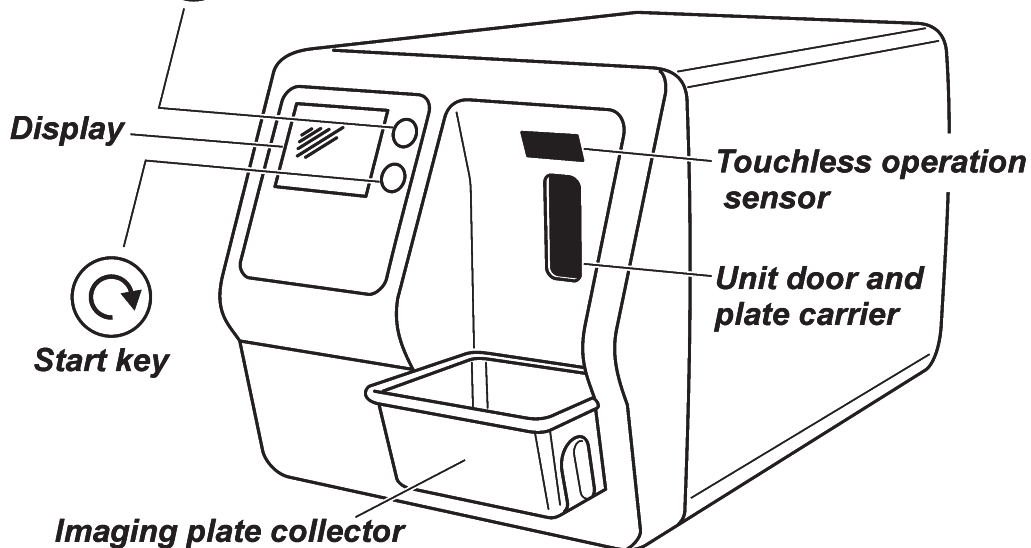

Rear of unit

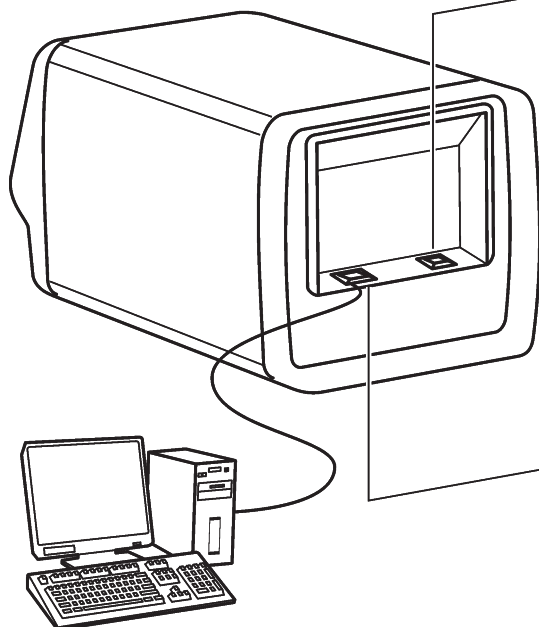

Power supply connector for the power supply unit (PSU).



CAUTION:

Only use the PSU supplied with the unit or an approved spare PSU supplied by an authorized distributor. (Refer to **technical specifications**)

RJ-45 connector for Ethernet cable:
 - direct connection to PC
 - network (LAN) connection
 Ethernet cable (not included)
 (Refer to **technical specifications**)

PC (not included) with digital imaging software that conforms to the MDD

2.2 Accessories

For additional information about the accessories listed below contact your authorized dealer. Not all accessories are available separately for all units.



Imaging plates (IPs). Equivalent to film sizes 0, 1, 2 and 3.

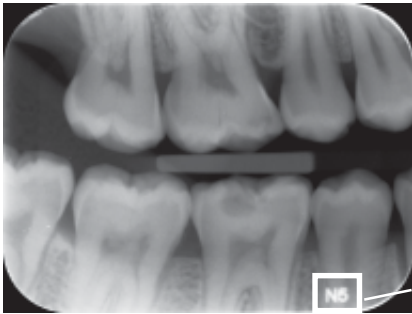

IDOT version. IDOT IPs (optional) have individual identification codes that appear on the images. IDOT aids quality assurance by making it possible to identify the plates used to take individual images.

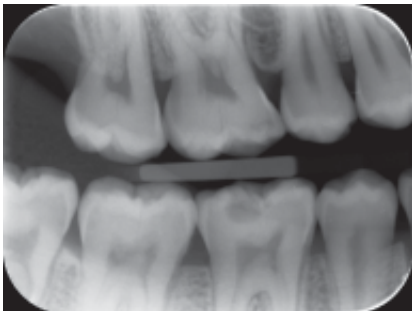

Standard (STD) version. The standard version has no identification mark on the active side of the plate.

Protective covers. For IPs 0, 1, 2 and 3.



Hygiene bags. For IPs 0, 1, 2, 3 and Comfort Occlusal™ 4C.

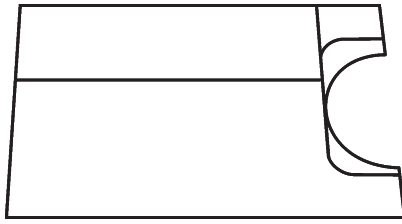

Comfort Occlusal™ 4C bite protector

For holding two size 3 IPs that are used for taking an occlusal projection image.

CAUTION:

For optimum performance only use IPs, protective covers and hygiene bags supplied by the manufacturer of the unit or the manufacturer's authorized distributors.

The manufacturer will not be held responsible for problems caused by using accessories from other manufacturers.

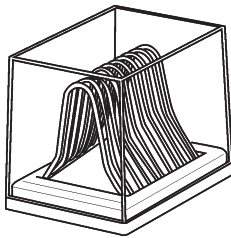

IP storage box

For storing IPs safely and conveniently.

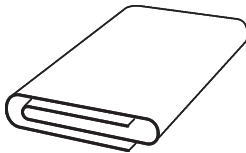

Microfiber cloth

For cleaning IPs.

IP holders

For bitewing, periapical and endodontic exposures (optional, not included)

See section **Imaging plate holders** for more information.

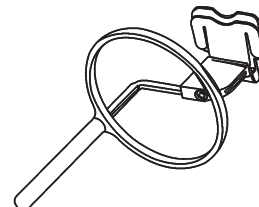
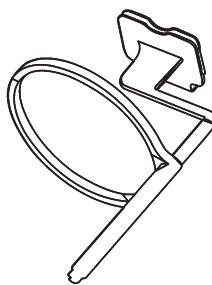
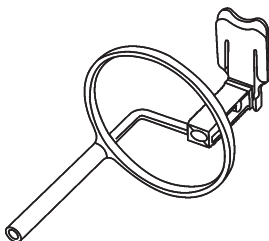

2.2 Display symbols and what they mean

During use symbols and animations will appear on the unit display. These:

- indicate the status of the unit
- help you to operate the unit correctly
- show user mistakes and corrective actions
- display error codes
- display a preview image

The main symbols are:

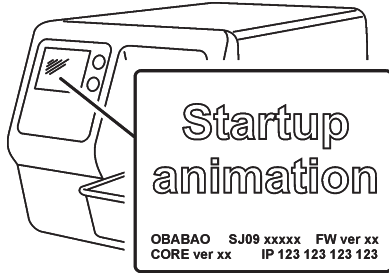

Startup

During startup the unit serial number, IP address and other information will appear on the unit display.



Patient name

Indicates a patient card is open. The patient's name is shown on the unit display.



Multiconnect wait

Multiconnect configuration. The unit is not reserved by any PC in the system.



Multiconnect reservation

Multiconnect configuration. The unit has been reserved by a PC (e.g. PC number 2).



UV disinfection in progress

The system is carrying out automatic UV disinfection cycle. Remaining cycle time will be displayed.



Comfort Occlusal™ 4C mode

System in occlusal projection imaging mode.

II**Comfort Occlusal™ 4C mode**

System in occlusal projection imaging mode, insert second size 3 IP.

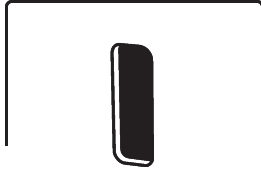

Unit door

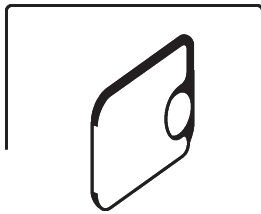

Protective cover and imaging plate

Yellow: remove protective cover

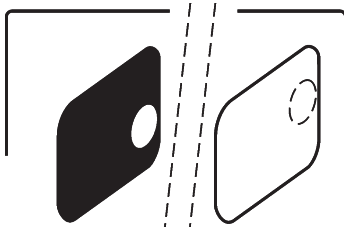

Imaging plate

Yellow: wrong way round, rotate

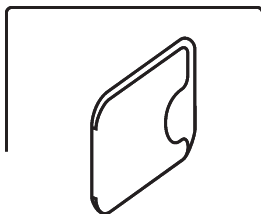

Protective cover

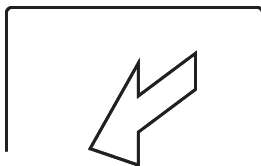

Remove / disconnect



Insert / connect



Progress
animation

Busy
Unit in operation.



Progress
animation
(blue)

UV disinfection
Unit in UV disinfection mode, the remaining/elapsed
disinfection time is shown.

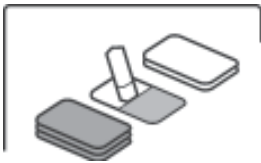

Unit in erasing mode



Check
Something wrong or take alternative action.

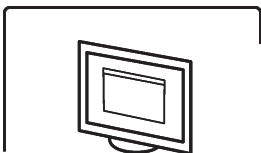

Dental imaging software
Software not open, not ready or waiting for user
action.

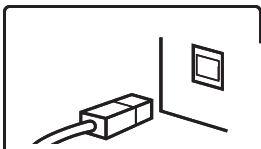

Unit connection
Not connected or connection not working.

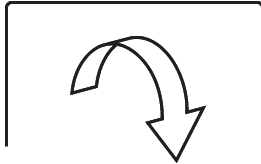

Rotate



Error state and error number



Check documentation supplied with the unit

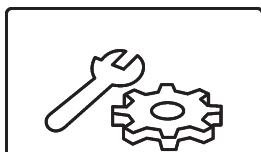

Unit in service mode
(Service technicians only)

3 Using the system

3.1 General

For optimum performance only use IPs, protective covers and hygiene bags designed for this unit and supplied by authorized distributors.

The manufacturer of this unit will not be held responsible for any problems caused by using accessories from other manufacturers.

Proper handling, cleaning and storage of the IPs ensures the best image quality and maximum service life of the IPs. Refer to section **4. Handling and care of imaging plates**.

IMPORTANT NOTE:

If you are using the system for the **first** time check the setup options to ensure that they are suitable for your work methods and dental environment. See section **Appendix B. Setup options**.

3.2 Preparing the system

1. **PC:** Switch on the PC connected to the unit.
2. **PC:** Open the dental imaging software and a new or existing patient card where you wish to store the intraoral images.
3. Press the **on/off** key to switch the unit on.



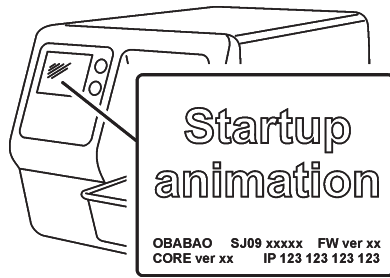

The startup animation will appear on the display and the unit will carry out self test during which the IP carrier will slide out of the unit door.



When the status light turns green and ready animation, indicating IP insertion, appears on the unit display, the unit is ready to use (in the ready state).

NOTE:

If the ready animation does not appear, check the system setup described in the installation instructions.

3.3 Preparing an IP for exposure

IMPORTANT NOTE:

If the IP is being used for the very first time or if it has not been used within the the last 24 hours, it must be erased before use to remove any fogging caused by background radiation. See section, **3.11 IP erasing mode (Initial erasing of the IPs)**.

CAUTION:

When handling IPs, protective covers and hygiene bags take all appropriate measures and precautions to prevent cross contamination.

NOTE:

If you are taking an occlusal projection exposure refer to section **3.12 Taking an occlusal projection image** and to the separate instructions supplied with the **Comfort Occlusal™ 4C** kit.

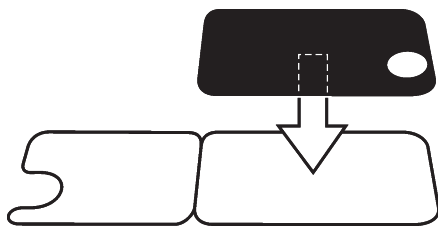

1. Place the IP you wish to use onto a protective cover. The **light blue** side (sensitive) of the IP must face and be placed on the half of the protective cover that is the same shape as the IP.



2. Fold the half of the protective cover with the semicircular cutout over onto the IP. The metal disk on the back (black side) of the IP must appear in the semicircular cut out.

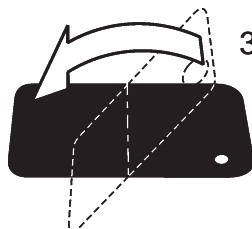

3. Turn the protective cover and IP over so that the black side of the protective cover is uppermost. This makes it easier to slide the protective cover and IP into the hygiene bag.

- Slide the protective cover and IP into the hygiene bag as far as they will go. Make sure that the black side of the protective cover is on the same side as the black side of the hygiene bag.



- Peel off the cover paper from the sealing tape and then fold the flap, along the pre-formed line, over and onto the sealing tape.

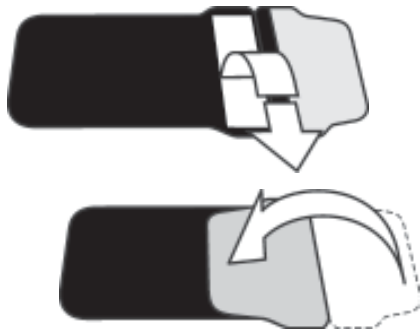

- Press and slide your thumb along the tape to ensure that the flap is properly sealed.



- Turn the sealed hygiene bag over and check that the IP and protective cover are in the correct position. You must be able to see the light side of the protective cover and the metal disk on the IP.

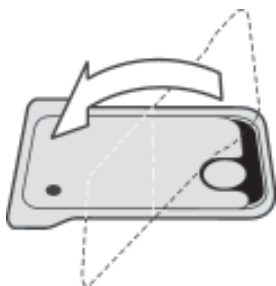

3.4 Imaging plate holders

It is recommended that imaging plate holders be used to ensure accurate IP positioning and consistently good images quality.

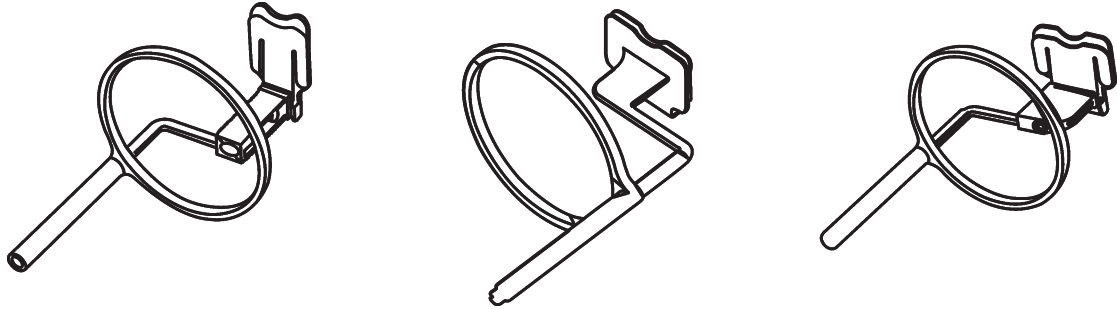

Using imaging plate holders improves image quality because:

- the IP is positioned correctly in relation to the tooth
- there is no positioning guesswork
- the IP is not bent and thus distortion is eliminated
- the IP cannot move in relation to the X-ray unit
- images are standardized and reproduceable
- there is no overlapping nor cone cut off
- IP wear and tear is minimized
- image quality can be maintained irrespective of who takes the image
- time is saved and profitability increased

Problems caused by manually positioning the IP include:

- incorrect vertical alignment
- distortion
- cone cut off
- poor projection standardization
- inferior image quality

For more information on imaging plate holders and systems contact your dealer.

3.5 Taking an exposure

1. Place the IP in its sealed hygiene bag, into the appropriate imaging plate holder and then insert it into the patient's mouth in the position for the image you wish to take.

Note that the back of the sealed hygiene bag, the black side, must face the X-ray source.

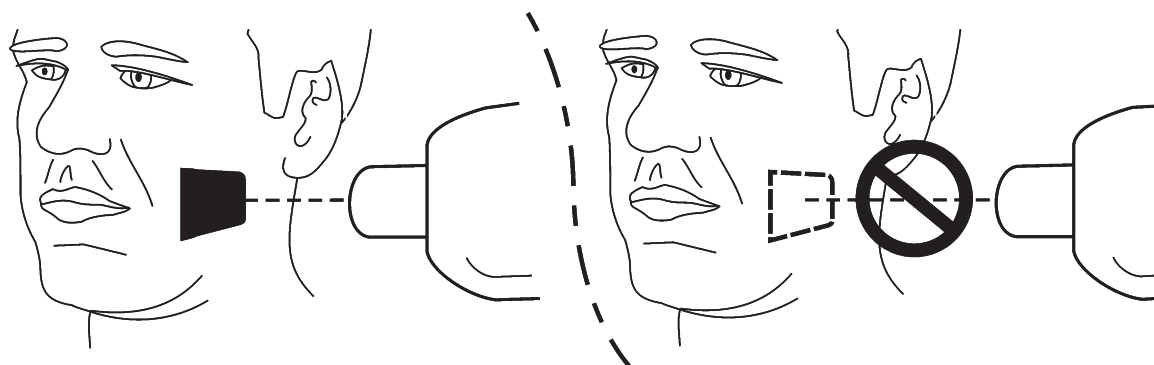

2. Select exposure values appropriate for the exposure you are taking.

The system will produce excellent images even if the exposure values differ considerably from the optimum values. In most cases the same exposure values can be used for virtually all imaging purposes.

For normal everyday use select the **Adult Bitewing** exposure time from the following table. If required the exposure time can be increased for very large patients and reduced for children.

The optimum exposure values also depends on the performance of the X-ray unit being used and may vary by ± 1 step from the values in the following table.

If the exposure time is too short images will be noisy. Such images may still be usable for some diagnostic purposes.

If the exposure time is too long images will be too dark or will show patient movement. These images will not be good enough for accurate diagnostic examination.

The exposure values table below should only be used as a guide.

Recommended exposure values (s) for DC x-ray units*

	60 kV, 7 mA				70 kV, 7 mA			
	9" cone		12" cone		9" cone		12" cone	
	Adult	Child	Adult	Child	Adult	Child	Adult	Child
Bitewing	0.250	0.160	0.500	0.300	0.125	0.080	0.250	0.160
Maxillary incisor	0.200	0.125	0.400	0.250	0.100	0.063	0.200	0.125
Maxillary cuspid	0.200	0.125	0.400	0.250	0.100	0.063	0.200	0.125
Maxillary molar	0.300	0.200	0.600	0.400	0.160	0.100	0.300	0.200
Occlusal	0.250	0.160	0.500	0.300	0.125	0.080	0.250	0.160
Mandibular incisor	0.200	0.125	0.400	0.250	0.100	0.063	0.200	0.125
Mandibular cuspid	0.250	0.160	0.500	0.300	0.125	0.080	0.250	0.160
Mandibular molar	0.250	0.160	0.500	0.300	0.125	0.080	0.250	0.160

*For AC x-ray units increase the exposure times by about 30%



3. **Protect yourself from radiation** and take the exposure.

4. After the exposure remove the sealed hygiene bag from the patient's mouth.

CAUTION:

If there is a risk of cross contamination, wash, disinfect and dry the hygiene bag before opening it.

3.6 Reading an imaging plate

Single user configuration

NOTE:

If the unit is operated in a multiconnect configuration, please refer to **Multiconnect configuration** first to reserve the scanner.

NOTE:

If you are taking an occlusal projection exposure refer to section **3.12 Taking an occlusal projection image** and to the separate instructions supplied with the **Comfort Occlusal™ 4C** kit.



1. Pull the flap to open the hygiene bag.



2. Keep the IP in the protective cover so that you do not touch the IP or allow it to be exposed to ambient light, and then slide the protective cover and IP out of the hygiene bag.



3. Hold the protective cover and IP so that the white side of the protective cover is on the right. The metal disk on the IP will also be on the right. Insert the protective cover and IP into the unit door. A magnet will hold the IP in the correct position.

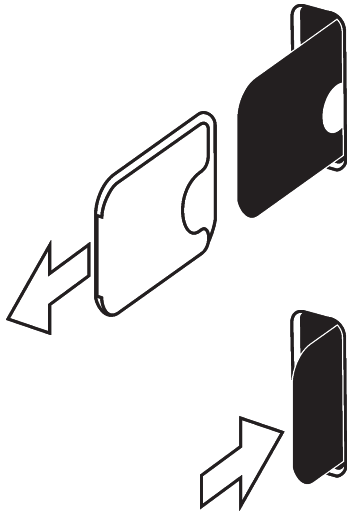

4. Slide the protective cover off of the IP, and leave the IP in position half way in the unit door.

As soon as the protective cover is removed the unit detects that the IP is in the unit door and will switch from the standby state to the ready state (ready to use) and automatically slide the IP into the unit.

CAUTION:

If the IP does not slide into the unit after the protective cover has been removed, the IP is misaligned or has been placed in the unit the wrong way round. Reposition the IP and insert it into the unit again.



If after repositing the IP it still does not slide into the unit press the **Start** key to manually switch the unit from the standby to the ready state and the IP will then slide into the unit when the protective cover is removed.

Progress
animation

The busy animation will appear on the display which indicates that the imaging plate is being read.

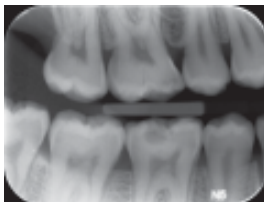

After few seconds a preview image will appear on the unit display

PC: A read-out progress window will appear on the PC display. After a few seconds the image will appear in the dental imaging software. The image can now be saved. Refer to the documentation supplied with the dental imaging software you are using.

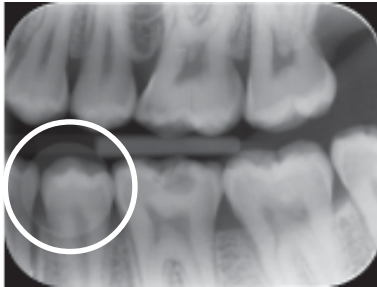

CAUTION:

If the metal disk on the rear of the IP can be seen on the digital image, it indicates that the IP was exposed from the wrong side.

CAUTION - RETRIEVING IMAGES

If the image is not transferred to the PC because of a network, PC or software failure, the image can be retrieved from the unit's memory as long as the unit is **NOT** switched off.

For information on how to do this see section **3.9 Retrieve last image.**

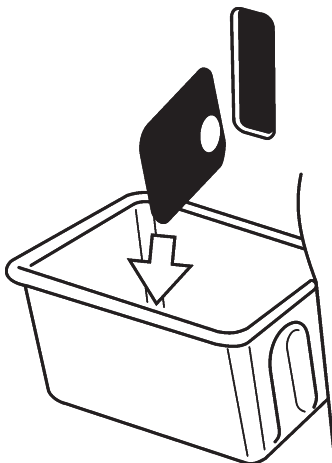

5. After the IP has been read it will be automatically erased and then ejected from the unit into the plate collector.

NOTE:

The unit can be configured so that the IP remains in the plate carrier (it is not ejected into the plate collector). When the IP is in the plate carrier the IP is easier to handle and stricter hygiene measures can be observed. Refer to **Appendix B 3.2 Workflow/Plate ejection mode.**

After the IP has been ejected or removed the ready animation will reappear on the display. The unit is now ready to read the next IP.

Multiconnect configuration

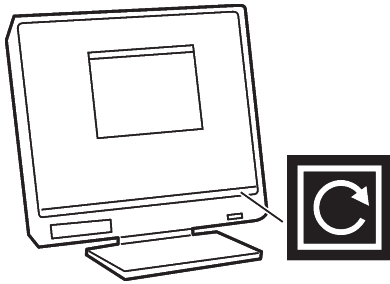

1. **PC:** To reserve the unit click the **GREEN** multiconnect icon, which is in the bottom right-hand corner of the PC display. The **Connect** window will appear.

2. **PC:** In the **Connect** window click the **Reserve the Scanner** button to reserve scanner.



Reserve the scanner

The window will disappear and the **GREEN** multiconnect icon will start to flash. This indicates that you have now reserved the unit and it can now be used to read an image.

NOTE:

If the multiconnect icon is **YELLOW**, it indicates that the unit has been reserved by someone else. Wait until the unit is free.

If you wish to know who has reserved the unit, place the cursor on the multiconnect icon (while yellow) and the message:

Scanner reserved by XXXX (where XXXX is the multiconnect ID of the PC that has reserved the unit) will appear.

NOTE:

If the multiconnect icon is **GRAY**, it indicates that the unit has not been switched on or is just starting up and is not yet ready for use.

Switch the unit on and / or wait until the unit is ready for use.

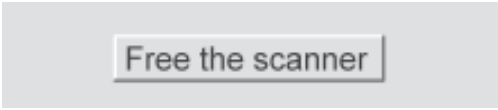

3. **PC:** To release the unit click the **GREEN** multiconnect icon and then click the **Free the scanner (unit)** button.

A rectangular button with a light gray background and a thin black border. The text "Free the scanner" is centered on the button in a dark gray font.

Free the scanner

3.7 Removing IPs from the plate collector

When removing IPs from the plate collector hold them by their edges. Alternatively, pull the plate collector out of the unit and tip the IPs out onto a flat clean surface. If they are not to be reused immediately or within a short period of time, store them in their storage box.

3.8 Standby mode

If no IP is inserted into the unit within a certain period of time, the unit will beep several times and the status light will start to flash. When status light turns yellow and the unit display turns off the unit is in the standby mode.



The unit will automatically exit the standby mode as soon as a new imaging plate is inserted into the unit or when the **Start** key is pressed.

After four hours the unit will exit the standby mode and automatically shut down.

3.9 Retrieve last image

If the last image read is not transferred to the PC because of a network, communication, PC or software failure, the last image read can be retrieved.

IMPORTANT NOTE

The LAST read image can only be retrieved if the unit is left on. **If the unit is switched off the image will be lost.**

To retrieve the last scanned image:

1. Correct the problem that caused the communication failure. When the connection between the unit and the PC is re-established the last read image will automatically be transferred to the PC.
2. **PC:** If the image is not automatically transferred to the PC, select the **Setup > Scanner** page from the dental imaging software you are using.
3. **PC:** In the **Last Image** field, click the **Retrieve now** button to retrieve the last read image.
NOTE:
If required you can select different parameters (e.g. resolution, show image preview etc.) for the image to be retrieved.
4. **PC:** Click **OK** to close the **Setup** window. The last read image will be transferred to the PC.

3.10 Shutting down the unit



1. Press and hold down the power on / off key. The UV disinfection cycle, when active (refer to section **Installation and set up / hygiene**), will be automatically carried out before the unit switches itself off.

If you wish to switch the unit off before the UV disinfection cycle is complete, press and hold down the power on / off key again (4 seconds) and the unit will shutdown.



If you wish to return to the normal operation mode, press and hold down (4 seconds) the start key.

NOTE:

If there is an untransferred image in the unit's memory the unit cannot be shut down. The image must be transferred first. Refer to section **3.9 Retrieve last image**.

3.11 IP erasing mode (Initial erasing of the IPs)

If an IP is being used for the very first time or has not been used for 24 hours and has not been exposed to ambient light the erasing procedure must be carried out before the IP is used. The erasing procedure removes any fogging due to background radiation. The dedicated erasing mode erases the IP but does not send the image (blank) to the dental imaging software.

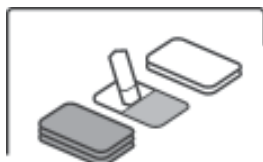

1. Press and hold down the **Start** key for several seconds until the erase mode animation appears on the unit display. The unit is now in the erase mode.

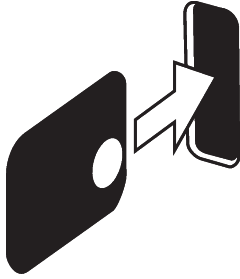

2. Hold the IP by its edges (or use a protective cover) and position it so that the side with the metal disk (the back) is on the right. Insert the IP into the unit door (remove the protective cover if used). A magnet will hold the IP in position and then automatically slide it into the unit.

NOTE:

It may take longer to erase IPs using the erasing mode than the normal read and erase mode. This is to ensure that IPs that have not been used recently are erased properly.

3. After the IP has been erased it will be ejected from the unit. The IP can now be used to take an exposure.



4. To exit the erasing mode, either wait 15 seconds for the unit to automatically exit the mode, or press and hold down the **Start** key until the erase animation disappears.

3.12 Taking an occlusal projection image

Comfort Occlusal™ 4C images are produced using TWO size 3 IPs, the Comfort Occlusal bite protector and the hygiene bag (The Comfort Occlusal 4C IP). Refer to the separate instructions supplied with the Comfort Occlusal™ 4C kit.

IMPORTANT NOTE:

Due to occlusal imaging geometry and imaging plate positioning, accurate distance and angle measurements cannot be taken from occlusal projection images.

1. **PC:** Select occlusal from **Setup > Scanner > Occlusal** (see section: **B3.5 Occlusal**).
2. Place two size 3 IPs into their corresponding protective covers.
3. Slide the two size 3 IPs and protective covers into the Comfort Occlusal bite protector. Insert the Comfort Occlusal bite protector and IPs into the Comfort Occlusal hygiene bag and seal the bag.
4. Place the sealed Comfort Occlusal 4C IP into the patient's mouth and take an exposure.
5. Remove the sealed Comfort Occlusal 4C IP from the patient's mouth.
6. Open the sealed Comfort Occlusal 4C IP. Remove the two size 3 IPs and scan them.

3.13 Errors and warnings



- If there is a problem with the unit the error state symbol and an error number will appear on the unit display.

Restart the unit. The error should clear. If not contact your authorized distributor for assistance.



- **Warning, UV lamp blown.**

NOTE:

The unit can still be used if the UV disinfecting lamp has blown. Press the start key to continue using the unit.

If you wish to disable UV disinfection completely see section: **B 3.4 Hygiene/Automatic UV disinfection/Disinfection frequency.**

- **PC:** If the message:

Degraded image quality

appears on the PC display during or after an IP is read it indicates that the image may not be within the factory set quality limits.

If the image looks okay no action is necessary. If the message appears frequently, contact your authorized distributor for assistance.

4. Handling and care of imaging plates

The correct use, handling, cleaning and storage of imaging plates guarantees the best image quality and maximum service life of the imaging plates.

4.1 General

- X-ray exposures DO NOT cause IPs to age.
- The light-coloured side of the IP is the side which “stores” the x-ray image. It is the SENSITIVE side!
- Image information “stored” on an IP after an exposure is sensitive to light.

4.2 Handling

- Handle IPs in the same way as you would handle CDs or DVDs.
- Hold IPs by their edges using your finger tips.
- Protect the sensitive side of the IP from:
 - scratches, wear and mechanical damage
 - stains, dirt, dust and fingerprints

NOTE:

Stains / fingerprints on the sensitive side can degrade the diagnostic value of the image
Dust/wear on the sensitive side can appear as white/grey spots on the image!

- Unprotected IPs must not come in contact with the patient, the patient's saliva or any other bodily fluids.
Always use hygiene bags and protective covers with IPs when taking exposures to:
 - eliminate cross contamination
 - maintain image quality
 - maximize IP service life.

4.3 Cleaning

If IPs are handled and stored correctly cleaning should not be necessary or can be kept to an absolute minimum.

Clean the IP if there you see any visible marks or stains (which are not obvious scratches) on the image or if there is a reason to believe that the IP is contaminated.

- Use the microfibre cloth supplied.
- First very gently wipe the IP in a backwards forwards movement in both the widthwise and lengthwise directions and then finish with a circular wiping movement.
- For stubborn marks and stains that cannot be be removed using the microfibre cloth, use 70...96% ethanol (70...96 EtOH / 30...4 DI WATER) or ethanol anhydride. Wipe the IP as described above and then wipe dry.

NEVER USE abrasive chemicals or materials to clean IPs.

Unsuitable cleaning solutions/methods may damage or destroy the IPs or leave residues on the sensitive surface that may appear on the images.

4.4 Storage

- Unpacked, exposed to ambient light in the dedicated storage box
- Below 33°C / 80% RH and shielded from X-rays and ultraviolet radiation.
- If an IP is stored for over 24 hours in a hygiene bag or in a location that is shielded from ambient light, the IP must be erased, to remove any potential fogging, before being used to take an exposure.

4.5 Replacement

Replace an IP if:

- the image shows marks, spots or dots, which still appear on images even after the IP has been properly cleaned.
- the IP is mechanically damaged (scratched) or badly bent.

4.5 Disposal

IPs must be disposed of in accordance with all local, national and international regulations regarding the disposal of non-environmentally friendly or hazardous materials.

Phosphor substance, under the top coat, on the sensitive side of IPs must not be swallowed.

5. Unit care and maintenance

WARNING

Switch the unit off and disconnect it from the main power supply before cleaning or disinfecting the unit. Do not allow liquids to enter the unit.

5.1 Cleaning the unit

Use a non abrasive cloth moistened with either:

- cool or lukewarm water,
- soapy water,
- mild detergent,
- butylalcohol,
- or ethanol (ethyl alcohol) 70 - 96%

to clean the unit. After cleaning wipe the unit with a non abrasive cloth moistened with water.

Never use solvents or abrasive cleaners to clean the unit. Never use unfamiliar or untested cleaning agents. If you are not sure what the cleaning agent contains, DO NOT use it.

If you use a spray cleaning agent DO NOT spray it directly into the unit door.

5.2 Disinfecting the unit

CAUTION

Wear gloves and other protective clothing when disinfecting the unit.

Wipe the unit with a cloth dampened with a suitable disinfectant solution such as ethanol 96%. Never use abrasive, corrosive or solvent disinfectants. All surfaces must be dried before the unit is used.

WARNING

Do not use any disinfecting sprays as the vapor could ignite and cause injury.

Disinfecting techniques for both the unit and the room where the unit is used must comply with all local and national regulations and laws concerning such equipment and its location.

5.3 Maintenance

The unit does not require any maintenance.

5.4 Repair

If the unit is damaged or malfunctions in any way it must only be repaired by service personnel authorized by the manufacturer of the unit.

5.5 Disposal

At the end of the useful working life of the unit and/or its accessories make sure that you follow national and local regulations regarding the disposal of the unit, its accessories, parts and materials. The unit includes some or all of the following parts that are made of or include materials that are non-environmentally friendly or hazardous:

- electronic circuit boards
- electronic components
- UV lamp (Hg)

6. Symbols that appear on or in the unit



DANGEROUS VOLTAGE



LASER RADIATION



ULTRAVIOLET RADIATION



IMPORTANT INFORMATION (Refer to user's manual)



Direct current

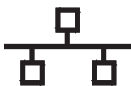

Ethernet connector RJ45 straight cable



CE (0537) Symbol MDD 93/42/EEC
This unit is marked according to the Medical Device Directive 93/42/EEC (if the unit contains the CE mark)



ETL symbol



This symbol indicates that the waste of electrical and electronic equipment must not be disposed as unsorted municipal waste and must be collected separately. Please contact an authorized representative of the manufacturer for information concerning the decommissioning of your equipment.

7. Warnings and precautions

THE UNIT IS A CLASS 1 LASER PRODUCT

Note! When covers are removed the unit is a class 3B laser product – avoid exposure to the laser beam or the UV-C light inside the unit.

CAUTION - Use of controls or adjustments or performance of procedures other than those specified herein may result in hazardous laser radiation exposure or excessive exposure to UV-C light.

- When handling imaging plates, protective covers and hygiene bags always take the appropriate hygiene measures and precautions to prevent cross contamination.
- The imaging plates are harmful if swallowed.
- Do not move or knock the unit when it is reading an imaging plate.
- This unit must only be used to read image plates supplied by the manufacturer and must not be used for any other purpose. NEVER use imaging plates, protective or hygiene bags from other manufacturers.
- This unit, or its accessories, must not be modified, altered or remanufactured in any way.
- Only the manufacturer's authorized service personnel are authorized to carry out maintenance and repair of the unit. There are no user serviceable parts inside the unit.
- Infection control procedures must be observed when using accessories, such as film holders, x-ray tube guides and imaging plates. When using accessories always follow the manufacturer's instructions on how to use the accessory and prevent cross contamination from one patient to another.
- This unit can interfere with other devices due to its EMC characteristics.
- Other devices can interfere with this unit due to their EMC characteristics.
- This unit complies with IEC 60601-1 standard. Accessory equipment connected to this device must be in compliance with the related nationally harmonized IEC standards.

- Unit not suitable for use in the presence of flammable anaesthetic mixture with air or with oxygen or nitrous oxide.
- For ethernet connections, use an unshielded CAT6 LAN cable, so that multiple chassis must not be connected! The PC / Ethernet switch to which unit is connected to, should be approved appropriately (e.g. EN 60950, IEC 60950, UL 60950). After installation check that the IEC 60601-1 leakage current levels are not exceeded.
- In order to maintain safe and correct functioning of the unit, only the power supply unit (PSU) delivered with the unit or distributed by authorized dealers. Please refer to the unit technical specifications for a list of the PSUs.
- If this device will be used with 3rd party imaging application software not supplied by the manufacturer, the 3rd party imaging application software must comply with all local laws on patient information software. This includes, for example, the Medical Device Directive 93/42/EEC and/or FDA if applicable.
- Medical electrical equipment needs special precautions regarding EMC and needs to be installed according to EMC information.

Appendix A. Technical Specifications

A.1 Unit

Intraoral imaging plate unit	
DXR 50 Classification IEC60601-1	- Class 1 or 2 equipment depending on the classification of the PSU. No applied part - Continuous operation - IPX0 (enclosed equipment without protection against ingress of liquids)
Laser Safety Classification	CLASS 1 LASER PRODUCT EN 60825-1 :2007
Dimensions (H x W x D)	190 mm x 200 mm x 383mm (7.5in x 7.8in x 15.1in)
Weight	9.8 – 10.3 kg (21.6 – 22.7 lb)
Power supply unit (PSU)	POWERBOX EMX 805121
Operating voltage	24 VDC (PSU: 100 – 240 VAC, 50/60 Hz)
Operating current	Less than 1.5 A
Pixel size, selectable	35 µm (Super), 64 µm (High)
Bit depth	14 bits grayscale
Clinical resolution	10 lp/mm
Spatial resolution	14.3 lp/mm
Interface cable	For Ethernet connections, use an unshielded CAT6 LAN cable, so that multiple chassis must not be connected! The PC / Ethernet switch to which unit is connected to should be approved appropriately (e.g. EN 60950, IEC 60950, UL 60950).
Operating environment	+10°C - +40°C, 30 – 90 RH%, 700 – 1060 mbar
Storage / transportation environment	-10°C – +50°C, 0 – 90 RH%, 500 – 1080 mbar

A.2 Imaging Plates and hygiene bags

Imaging plates (IP)					
Size	Size 0	Size 1	Size 2	Size 3	Size 4C
Dimensions (mm)	22 x 31	24 x 40	31 x 41	27 x 54	48 x 54 nominal
Image size (pixels), 35 µm	628 x 885	685 x 1143	886 x 1171	771 x 1542	1372 x 1542 nominal
Image size (KB), 35 µm	1085	1529	2026	2322	4000 nominal
Image size (pixels), 64 µm	484 x 344	625 x 375	641 x 484	844 x 422	750 x 843 nominal
Image size (KB), 64 µm	325	458	606	695	1150 nominal
Storage environment	Imaging plates must be stored in their protective box below 33°C. The box must be kept closed to remain dust free.				
Material	Photo-stimulable phosphor uniformly coated on a support plastic material. Shielded with a top coat layer on active surface and encapsulated with lacquer around edges				
Disposal	Imaging plates are industrial waste and must be disposed of in accordance with local and national regulations concerning the disposal of such material.				

Hygiene bags	
Material	Food-grade polyethylene - Latex free
Packaging	Supplied in boxes
Disposal	Observe relevant national requirements.

A.3 Main dimensions

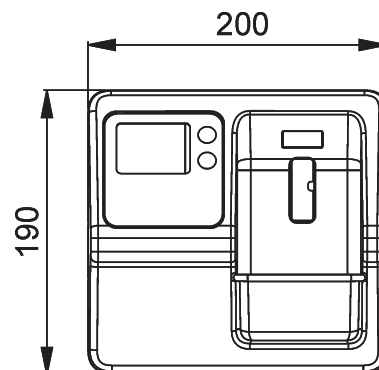
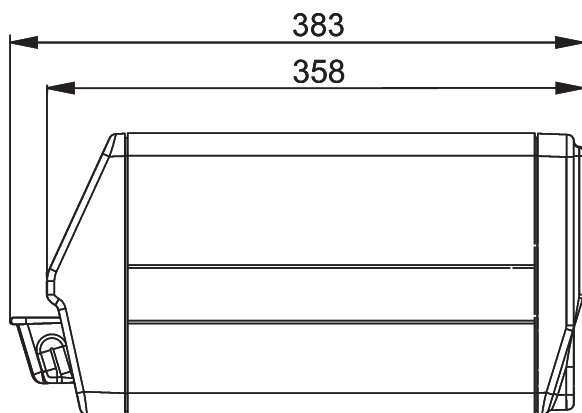

Guidance and manufacturer's declaration – electromagnetic emissions		
The DXR-50 is intended for use in the electromagnetic environment specified below. The customer or the user of the DXR-50 should assure that it is used in such an environment.		
Emissions test	Compliance	Electromagnetic environment - guidance
RF emissions CISPR 11	Group 1	The DXR-50 uses RF energy only for its internal function. Therefore, its RF emissions are very low and are not likely to cause any interference in nearby electronic equipment.
RF emissions CISPR 11	Class B	The DXR-50 is suitable for use in all establishments, including domestic establishments and those directly connected to the public low-voltage power supply network that supplies buildings used for domestic purposes.
Harmonic emissions IEC 61000-3-2	Class A	
Voltage fluctuations/ flicker emissions IEC 61000-3-3	Complies	

Guidance and manufacturer's declaration – electromagnetic immunity			
The DXR-50 is intended for use in the electromagnetic environment specified below. The customer or the user of the DXR-50 should assure that it is used in such an environment.			
Immunity test	IEC 60601 test level	Compliance level	Electromagnetic environment - guidance
Electrostatic discharge (ESD) IEC 61000-4-2	±6 kV contact ±8 kV air	±6 kV contact ±8 kV air	Floors should be wood, concrete or ceramic tile. If floors are covered with synthetic material, the relative humidity should be at least 30 %.
Electrical fast transients/bursts IEC 61000-4-4	±2 kV for power supply lines ±1 kV for input/output lines	±2 kV for power supply lines ±1 kV for input/output lines	Mains power quality should be that of a typical commercial or hospital environment.
Surge IEC 61000-4-5	±1 kV differential mode	±1 kV differential mode	Mains power quality should be that of a typical commercial or hospital environment.
Voltage dips, short interruptions and voltage variations on power supply lines IEC 61000-4-11	<5 % U_T (>95 % dip in U_T) for 0.5 cycle 40 % U_T (60 % dip in U_T) for 5 cycles 70 % U_T (30 % dip in U_T) for 25 cycles <5 % U_T (>95 % dip in U_T) for 5 sec	<5 % U_T (>95 % dip in U_T) for 0.5 cycle 40 % U_T (60 % dip in U_T) for 5 cycles 70 % U_T (30 % dip in U_T) for 25 cycles <5 % U_T (>95 % dip in U_T) for 5 sec	Mains power quality should be that of a typical commercial or hospital environment. If user of the DXR-50 requires continued operation during power mains interruptions, it is recommended that the DXR-50 be powered from an uninterruptible power supply or a battery.
Power frequency (50/60 Hz) magnetic field IEC 61000-4-8	3 A/m	3 A/m	Power frequency magnetic field should be at levels characteristic of a typical location in a typical commercial or hospital environment.
NOTE U_T is the a.c. mains voltage prior to application of the test level.			

Guidance and manufacturer's declaration – electromagnetic immunity			
The DXR-50 is intended for use in the electromagnetic environment specified below. The customer or the user of the DXR-50 should assure that it is used in such an environment.			
Immunity test	IEC 60601 test level	Compliance level	Electromagnetic environment - guidance
Conducted RF IEC 61000-4-6	3 Vrms 150 kHz to 80 MHz	3 V	<p>Portable and mobile RF communications equipment should be used no closer to any part of the DXR-50, including cables, than the recommended separation distance calculated from the equation applicable to the frequency of the transmitter.</p> <p>Recommended separation distance $d = 1.2 \sqrt{P}$ $d = 1.2 \sqrt{P}$ 80 MHz to 800 MHz $d = 2.3 \sqrt{P}$ 800 MHz to 2.5 GHz</p>
Radiated RF IEC 61000-4-3	3 V/m 80 MHz to 2.5 GHz	3 V/m	<p>where P is the maximum output power rating of the transmitter in watts (W) according to the transmitter manufacturer and d is the recommended separation distance in metres (m).</p> <p>Field strengths from fixed RF transmitters, as determined by an electromagnetic site survey,^a should be less than the compliance level in each frequency range.^b</p> <p>Interference may occur in the vicinity of equipment marked with the following symbol:</p> 
NOTE 1 At 80 MHz and 800 MHz, the higher frequency range applies.			
NOTE 2 These guidelines may not apply in all situations. Electromagnetic propagation is affected by absorption and reflection from structures, objects and people.			
<p>^a Field strengths from fixed transmitters, such as base stations for radio (cellular/cordless) telephones and land mobile radios, amateur radio, AM and FM radio broadcast and TV broadcast cannot be predicated theoretically with accuracy. To assess the electromagnetic environment due to fixed RF transmitters, an electromagnetic site survey should be considered. If the measured field strength in the location in which the DXR-50 is used exceeds the applicable RF compliance level above, the DXR-50 should be observed to verify normal operation. If abnormal performance is observed, additional measures may be necessary, such as reorienting or relocating the DXR-50.</p> <p>^b Over the frequency range 150 kHz to 80 MHz, field strengths should be less than 3 V/m.</p>			

Recommended separation distances between portable and mobile RF communications equipment and the DXR-50.			
The DXR-50 is intended for use in an electromagnetic environment in which radiated RF disturbances are controlled. The customer or the user of the DXR-50 can help prevent electromagnetic interference by maintaining a minimum distance between portable and mobile RF communications equipment (transmitters) and the DXR-50 as recommended below, according to the maximum output power of the communications equipment.			
Rated maximum output power of transmitter W	Separation distance according to frequency of transmitter m		
	150 kHz to 80 MHz $d = 1.2 \sqrt{P}$	80 MHz to 800 MHz $d = 1.2 \sqrt{P}$	800 MHz to 2.5 GHz $d = 2.3 \sqrt{P}$
0.01	0.12	0.12	0.23
0.1	0.38	0.38	0.73
1	1.2	1.2	2.3
10	3.8	3.8	7.3
100	12	12	23
For transmitters rated at a maximum output power not listed above, the recommended separation distance d in meters (m) can be estimated using the equation applicable to the frequency of the transmitter, where P is the maximum output power rating of the transmitter in watts (W) according to the transmitter manufacturer.			
NOTE 1. At 80 MHz and 800 MHz, the separation distance for the higher frequency range applies.			
NOTE 2. These guidelines may not apply in all situations. Electromagnetic propagation is affected by absorption and reflection from structures, objects and people.			

Appendix B. Installation and setup

Installation and setup must only be carried out by service personnel trained and approved by the manufacturer of the unit.

B1 System installation

Positioning the unit

Position the unit on a stable flat surface that is not effected by vibrations that could degrade the image quality.

The unit can also be attached to a wall, under or on a shelf using the optional **scanner mounting kit** (pt. no. 204138).

Do not position the unit in direct sunlight or near bright light. Sunlight or bright light must not be allowed to shine directly on the unit door into which the IPs are inserted.

The unit must not be positioned so that it touching other equipment. The unit must not be placed on top of or under other equipment.

The unit can be positioned within the environment in which the patient is examined and treated (patient environment).

Positioning the PC(s) (not supplied)

The PC(s) connected to the unit should not be used in the patient environment.

The minimum horizontal distance between the patient and the PC(s) is 1.5 m (4.5 ft).

The minimum vertical distance between the patient and the PC(s) is 2.5 m (6.5 ft).

Other devices

DO NOT connect any other devices to the unit or the PC(s) connected to the unit that are:

- not part of the supplied system
- not supplied by the manufacturer of the unit
- not recommended by the manufacturer of the unit.

B2 Connecting the unit to a PC / LAN

The procedure for connecting the unit to a single PC or several PCs in a local area network (LAN) is exactly the same except that every PC in the LAN needs to be given a unique ID number.

Direct connection method (uses the unit s/n)

1. After positioning the unit connect it to the PC(s) in the local area network using the Ethernet cable(s), not supplied.

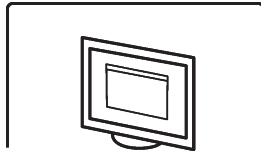

2. Switch the unit on.
The dental imaging software animation will appear. This indicated that the unit is not communicating with the PC(s) in the network.
3. **PC:** Install the dental imaging software to be used in the PC(s).
4. **PC:** Open the dental imaging software and select the scanner setup window.

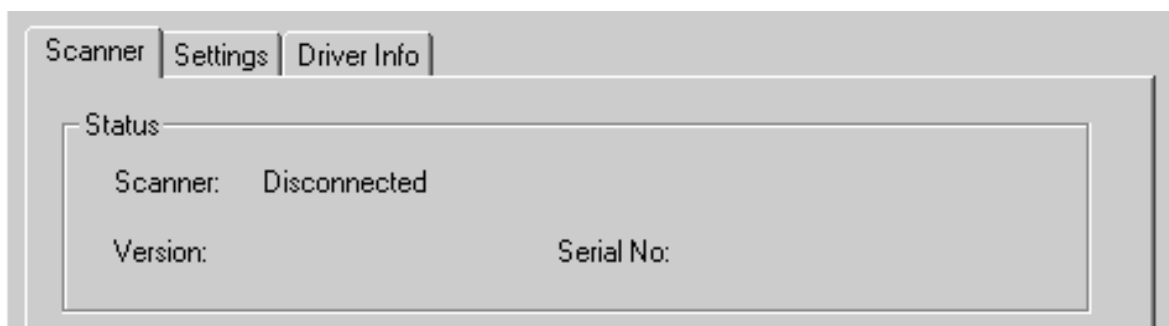

5. **PC:** From the scanner setup window select the **Settings** tab to open the **Scanner Connection** page.

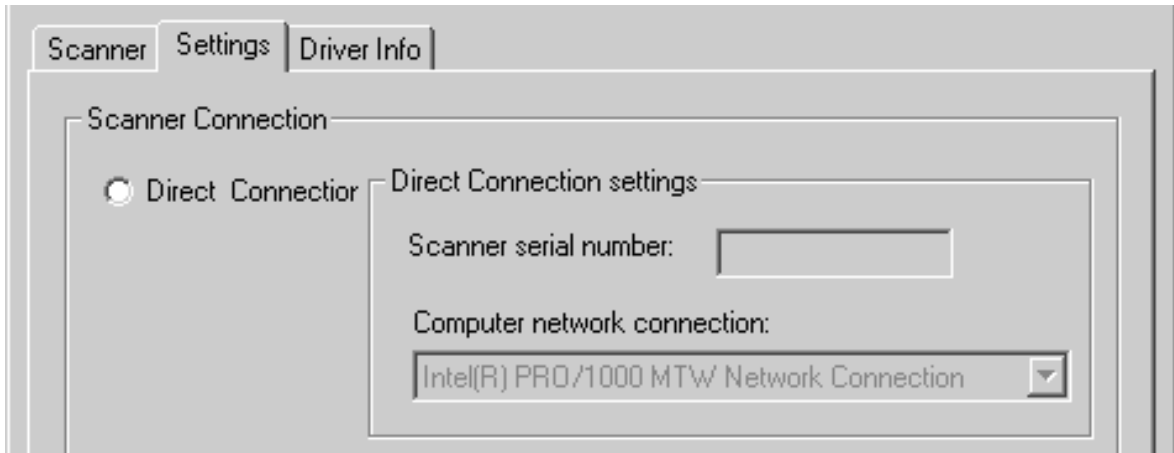

6. **PC:** Select **Direct Connection**.

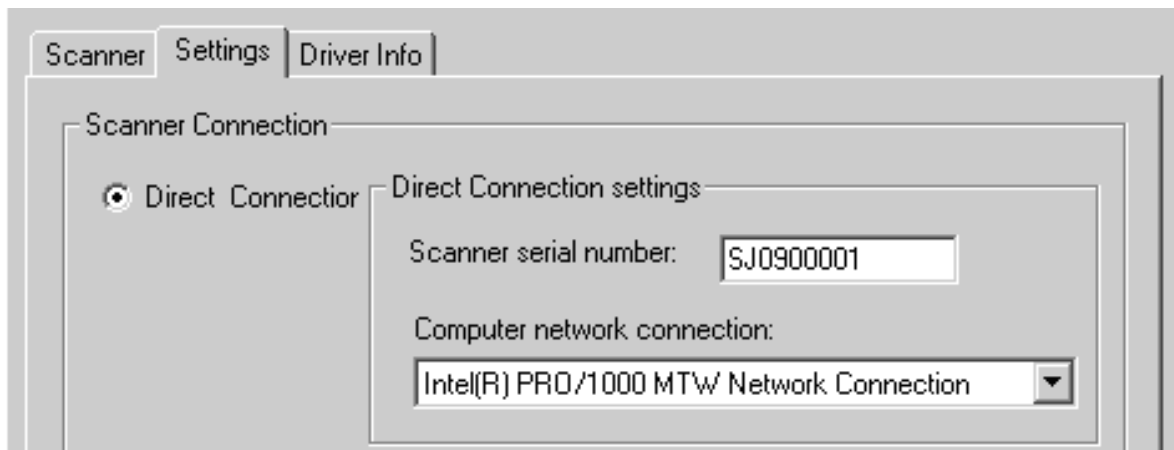

Key the serial number of the unit into the **Scanner serial number** field. The serial number of the unit will appear on the unit display when the unit is switched on. It can also be found on the type label on the back of the unit. Make sure that the **Computer network connection** that provides the LAN network connection is selected.

- PC:** If the unit is to be used with several PCs select the **Use Multi-Connect** check box. and select a unique **Workstation identifier** number (between 1 and 8), for the PC being configured, from the drop down list. Addition workstation information, for example, user name, location etc, can be entered into the field next to the work station identifier number.

IMPORTANT NOTE:

If only one PC is connected to the unit do not select the **Use Multi-Connect** check box.

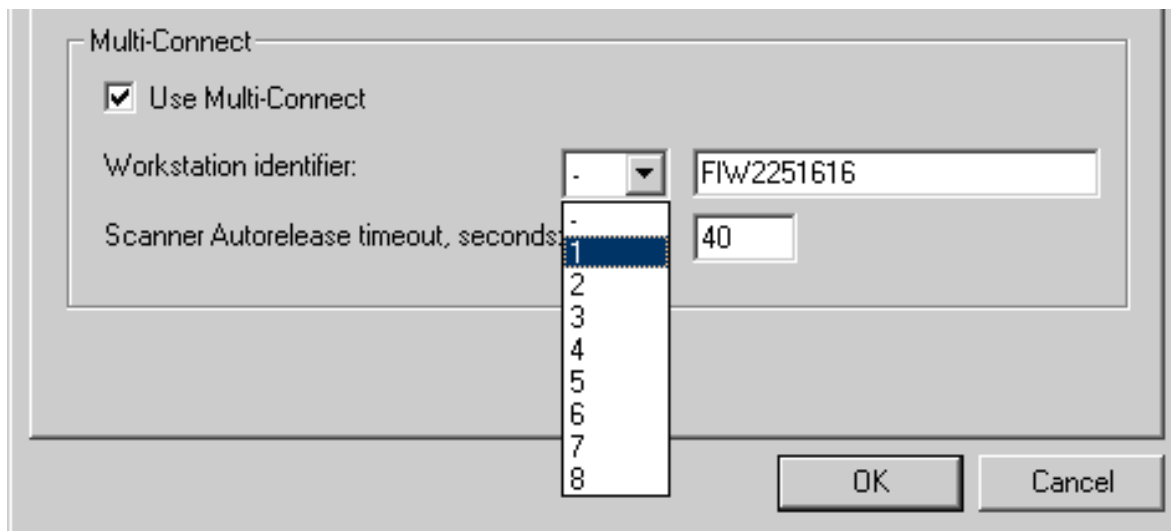

The **Scanner Autorelease timeout** is the length of time that the unit will remain reserved and **unused** by a PC before the PC automatically released the unit so that it can be used by another PC in the system (the scanner can be reserved in advance from another PC).

The default setting is 40 seconds. This can be changed by keying in a new value

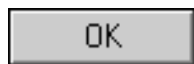

- Click **OK** to connect the PC to the unit.

NOTE:

An automatic technique will automatically locate the unit within the local area network and connect the PC.

- Repeat the above process for all the other PCs in the network. Make sure that you give each PC a different **Workstation identifier**.



- Check the installation by starting image capture using the imaging software.
If the **Use Multi-Connect** was selected the Workstation identifier of the PC (1 - 8) being used will appear on the unit display.

IP method (using the unit IP address)

If your system does not allow the direct connection method to be used to connect the PC(s), connection can be done using an IP address

- Follow steps 1 to 5 from the previous section, **Direct connection method (uses the unit s/n)**.
- PC:** From the the **Settings** tab select **IP based** and then select the **Enable changing IP address** box.

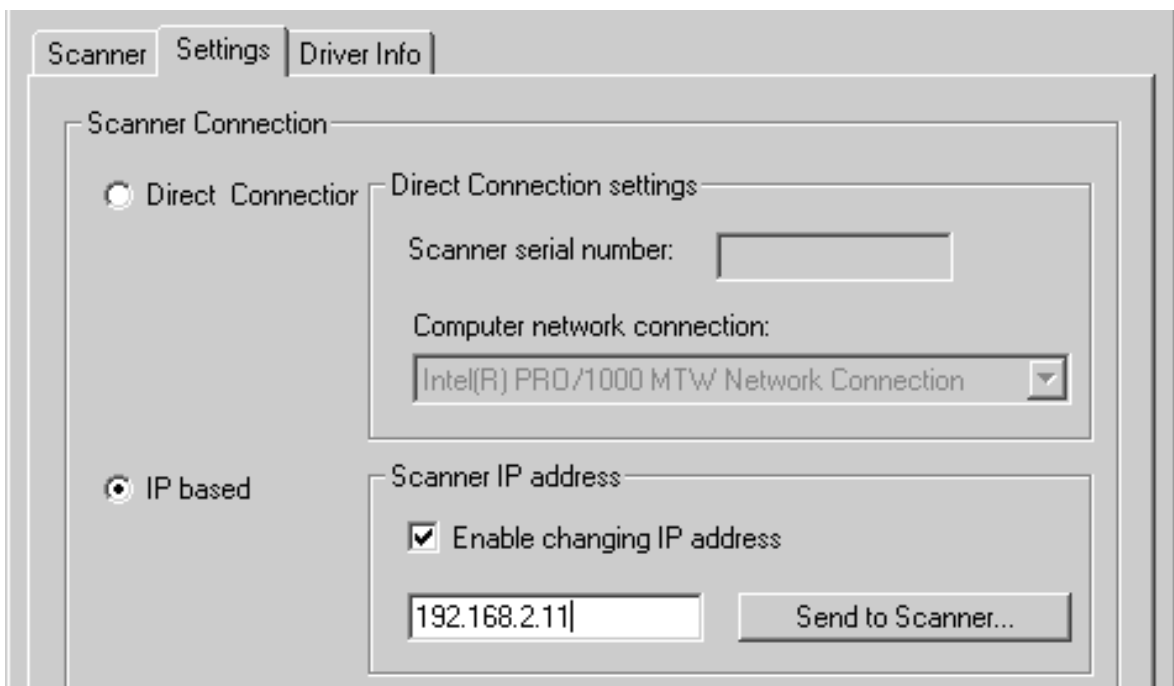



Obtain an IP address for the unit from your network administrator and key it into the IP field in the **Scanner IP address** area.

NOTE! The PC and the unit must be in the same subnet when setting the IP address of the unit.



3. **PC + Unit:** Press and hold down the **Start** key on the unit and then click the **Send to Scanner** button on the settings window.

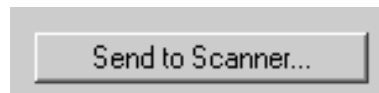

You will hear a beep which indicates that the PC is now sending the IP address the unit. The **Startup** animation will appear on the unit display

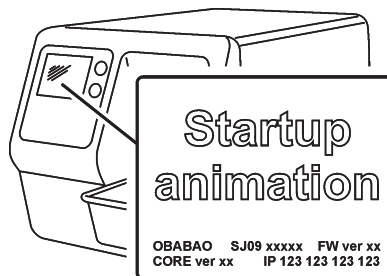

4. **PC:** When the **Startup** animation clears click **OK** to connect the PC to the unit.

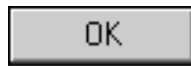

5. Now connect the other PCs in the network to the unit. Just enter the IP address into the IP field and then click **OK** to connect the PC to the unit (it is not necessary to hold down the **Start** key and click the **Send to Scanner** button with the other PCs once the unit has already got an IP address).

B3 Setup options

The scanner setup options allow you to configure the scanner to the user's clinical requirements.

B3.1 Scanner

1. From the dental imaging software you are using select **Setup / Scanner** page.

The screenshot shows a 'Scanner' setup dialog box with several tabs: Scanner, Settings, Workflow, Power options, Hygiene, Occlusal, and Driver Info. The 'Scanner' tab is active. The dialog is divided into several sections:

- Status:** Scanner: DIGORA Optime, Version: 5.10, Serial No: SJ0900022
- Image Scanning:** Show Image Preview and Dental Chart, Resolution: Super, High
- Image Processing:** Noise Filtering
- Last Image:** Retrieve latest image from the scanner unit memory.
- Scanner Unit Serial Number:** Add serial number to new images

At the bottom right, there are 'OK' and 'Cancel' buttons.

Status

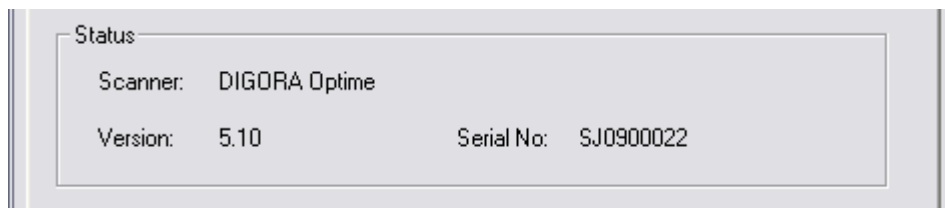

Shows the scanner type, version and serial number.

Image Scanning

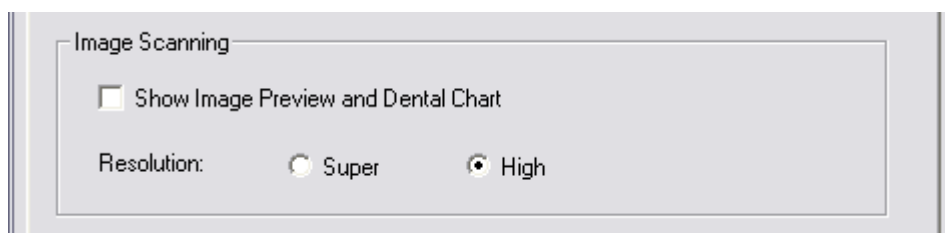

If **Show Image Preview and Dental Chart** is selected a preview image with a dental chart for tooth numbering will appear before the image is saved.

Using the dental chart

1. After an IP has been read a window will open that shows a preview image and a dental chart.
2. Click the **tooth / teeth** on the chart that correspond to the tooth / teeth in the image. Tooth numbers will be assigned to the selected teeth.

The tools at the top of the window allow the image to be manipulated.

3. Click **OK** to save the image and tooth numbers.

Resolution

Super gives a pixel size of 35 μ . This results in images with better resolution, but more memory is required as the image files are larger.

High (default) gives a pixel size of 64 μ . This results in images with less noise especially if short exposure times are used.

Image Processing

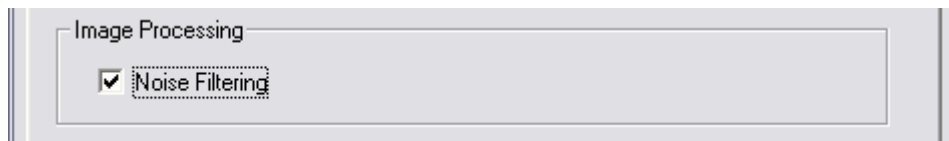

Noise Filtering, normally selected, makes images smoother when they are taken at low radiation doses.

Last image

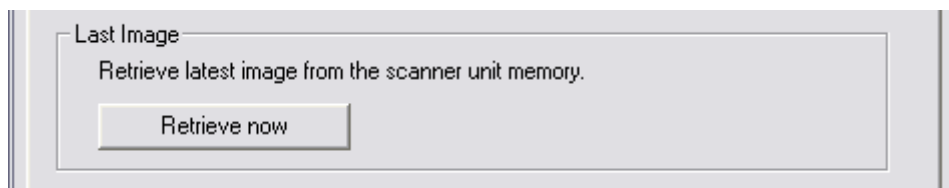

Refer to section **3.9 Retrieve last image**.

Scanner Unit Serial number

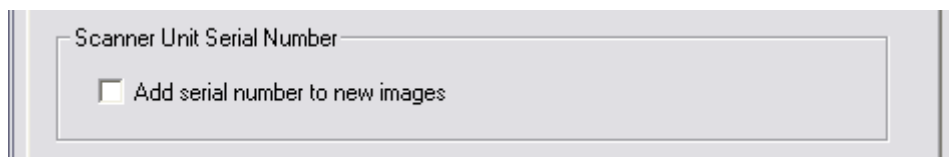

Adds the unit serial number to all new images.

See **B1 System installation** for information on **Settings**.

B3.2 Workflow

1. From the dental imaging software you are using select **Setup / Workflow** page.

The screenshot shows a software dialog box with the following sections:

- Scanner** | **Settings** | **Workflow** | **Power options** | **Hygiene** | **Occlusal** | **Driver Info**
- Readout start**
 - Automatic**
 - Start after: **Plate insert** (dropdown)
 - Start delay: **Medium** (dropdown)
 - Manual**. Start readout by pressing unit's START key.
- Touchless operation**
 - Scanner will wake up automatically from standby mode if touchless operation sensor is in use and activated.
 - Use touchless operation sensor**
- Plate eject mode**
 - Drop in plate collector** (dropdown)
- Restore factory settings**
 - Resets the Workflow, Power options and Hygiene values to their factory settings.
 - Restore factory settings** (button)

Buttons: **OK** | **Cancel**

Readout start

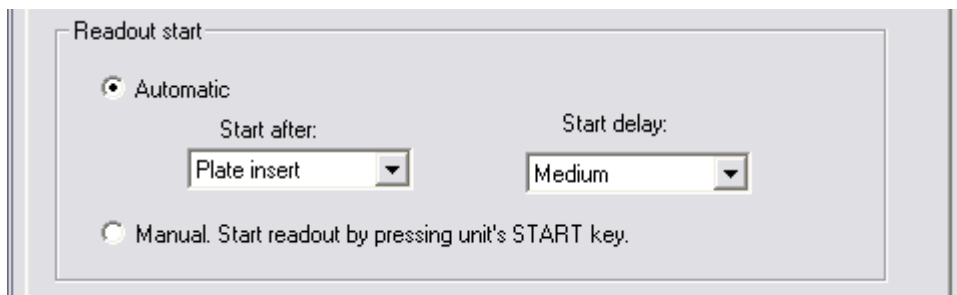

Readout start

Automatic

Start after:

Start delay:

Manual. Start readout by pressing unit's START key.

Select **Automatic** if you want the scanner to start automatically.

The **Start after** options allow to select when the scanner will start:

- after **Plate insert**: the scanner will automatically start when it detects and IP in the plate carrier.
- after **Cover removal**: after the IP and protective cover have been inserted into the plate carrier, the unit will automatically start when the protective cover is removed.

The **Start delay** options allow the the start delay time to be selected.

- **Short** = approximately 0.2 seconds
- **Medium** = approximately 0.4 seconds
- **Long** = approximately 0.6 seconds



Select **Manual** if you want the unit to start reading an IP only when the **Start** key is pressed.

Touchless operation



If **Use touchless operation sensor** is selected the unit will automatically “wake up” from the standby mode as soon as the sensor detects a movement within a distance of 20 cm.



If it is **NOT** selected the unit will “wake up” when the start is pressed.

Plate eject mode



The options are:

- **Drop in plate collector:** the IP is ejected into the plate collector after the IP has been scanned.
- **Leave in plate carrier:** the IP remains in the plate carrier after the IP has been scanned. The **Leave in plate carrier** option is recommended for users who want to handle the IPs with more care and reduce wear and tear on them. This option extends IP service life and allows greater hygiene standards to be observed.

B3.3 Power options

1. From the dental imaging software you are using select **Setup / Power options** page.

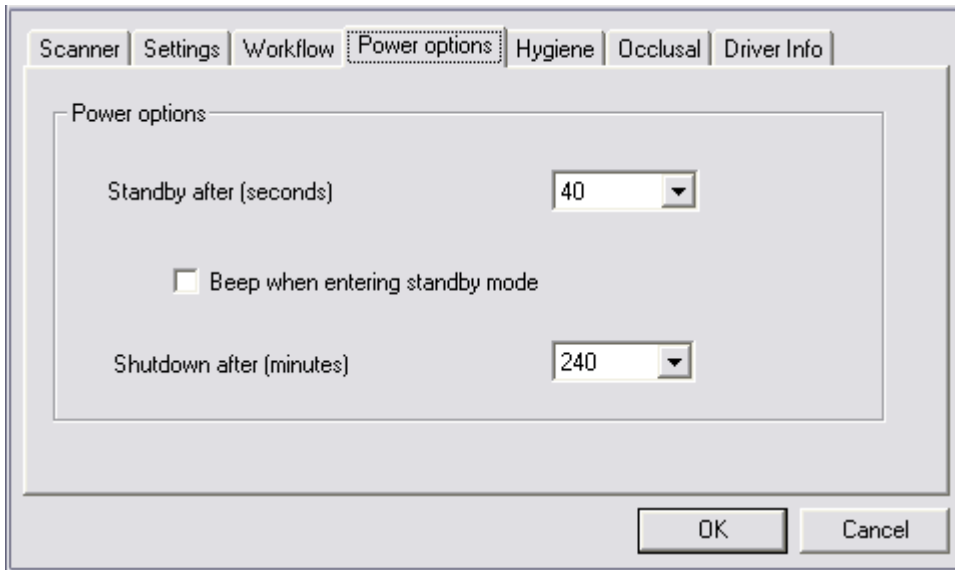

Power options

Standby after (seconds): Allows you to select the length of time the scanner will remain unused before it enters the standby mode (Display switches off and power LED turns yellow).

Beep when entering standby mode: Select this and audible signal will be heard when the scanner enters the standby mode.

Shutdown after (minutes): Allows you to select the length of time the scanner will remain unused before the unit automatically switches itself off.

NOTE:

If the **Automatic UV disinfection** option (**Hygiene**) is selected, the UV disinfection cycle will be automatically carried out before the unit switches itself off.

B3.4 Hygiene

1. From the dental imaging software you are using select **Setup / Hygiene** page.

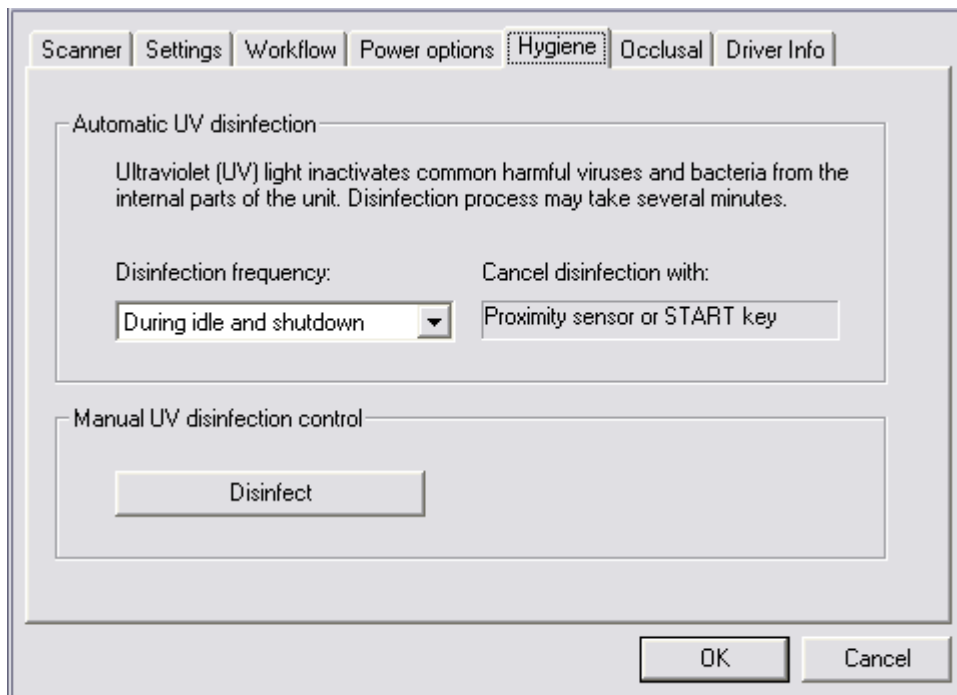

Automatic UV disinfection

The internal ultraviolet (UV) light allow you to disinfect the plate carrier when it is inside the scanner.

Disinfection frequency: There are three options:

- **During idle and shutdown:** UV disinfection is automatically performed when the unit is in the idle mode and before shutdown. There is no user indication of this taking place.
- **After each patient:** UV disinfection is automatically carried out after the patient card is closed. The remaining UV disinfection time appears on the unit display.

- **Disable** the user can switch off UV disinfection so that it does not operate. Also, all warning messages related to UV lamp status are discarded.

NOTE:

If any automatic UV disinfection mode is selected a UV disinfection cycle will ALWAYS be automatically carried out when the unit is switched off and prior to final unit shutdown

During this shutdown UV disinfection cycle the remaining disinfection time will appear on the unit display.

If you wish to stop the UV shutdown disinfection cycle :



- Press and hold down (4 seconds) the power on / off key, the unit will immediately shutdown.

or



- Press and hold down (4 seconds) the start key, the unit will return to the normal operation mode.

Manual UV disinfection control

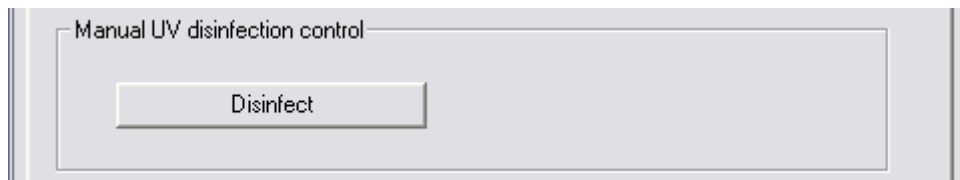

Click the **Disinfect** key to manually start and stop (**Cancel**) UV disinfection. The elapsed disinfection time will appear on the unit display. UV disinfection will automatically stop after 15 minutes.

If you wish to stop manual UV disinfection before the complete cycle is finished, press the **Manual UV disinfection control / Cancel** key or press and hold down (4 seconds) the start key.



B3.5 Occusal

From the dental imaging software you are using select **Setup / Occlusal** page.

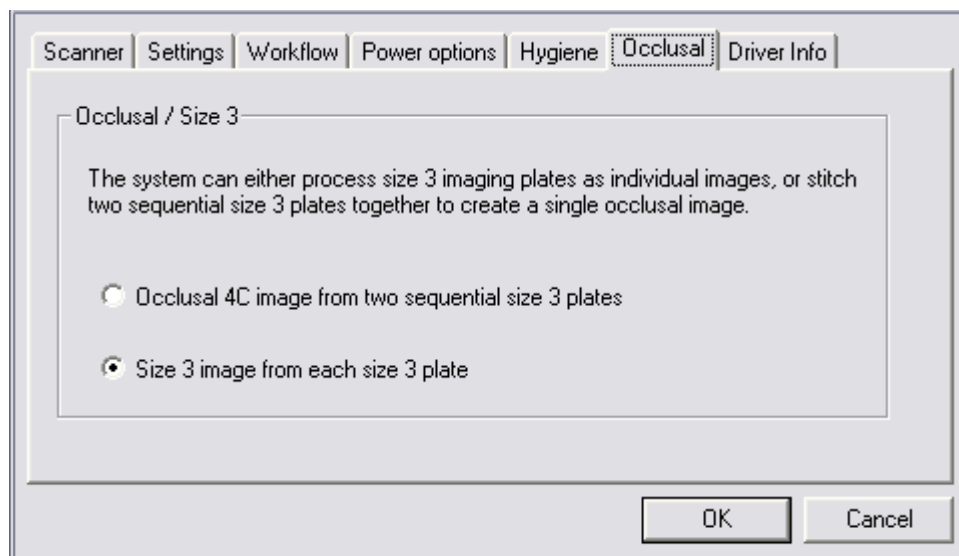

Occlusal / Size 3

Occlusal 4C image from two sequential size 3 plates allows the two size 3 IPs, used in the Comfort Occlusal 4C IP, to be scanned separately and then joined to form and single occlusal image.

Refer also to **3.13 Taking and occlusal projection image** and the Occlusal quick guide.

NOTE:



If you wish to scan a **single** size 3 IP when in the Occlusal 4C mode, scan the size 3 IP and then press the **start key** when the **insert second plate sign** appears on the unit display. This will cancel the occlusal mode.

Size 3 image from each size 3 plate allows size 3 IPs to scanned as individual IPs.

B4 Troubleshooting

PROBLEM

The unit does not come on. The unit's power on / off status light and display are off.

CAUSE / SOLUTION

The main power supply to the unit is off or the unit is not switched on.

- i. If the LED on the PSU is not on it is not receiving power from the mains. Switch the mains power on.
- ii. If the LED on the PSU is on switch the unit on.
- iii. If status light and display still do not come on check the unit's membrane control panel and cabling. Replace if faulty.

PROBLEM

Animation displaying either **Unit connection** or **Dental imaging software** (flashing yellow) appear on the unit display and the unit will not work.



CAUSE / SOLUTION

- Defective RJ45 cable. Replace.

PROBLEM

The IP-connection between the unit and the PC does not work.

CAUSE / SOLUTION

- i. Check that the **Direct** connection method was configured correctly. If all the settings are correct but the connection still does not work, use the **IP** connection method.
- ii. The unit has been configured to work with one PC only and does not recognize any other PCs. Reconfigure the system for multiple users.

PROBLEM

The unit is connected to the PC but cannot scan images.

CAUSE / SOLUTION

- i. Reserve the unit and check that it is configured for multiple users. If not, reconfigure the system.
- ii. If the **Dental imaging software** animation (flashing yellow) appears, it indicates that a patient has not been selected for the scanned image(s). Select a patient.
- iii. If the **Insert** animation appears on the unit display while inserting the IP but the unit does not insert the IP into the unit nor start scanning, the reflective sensor in the unit door is faulty (refer to the service manual).

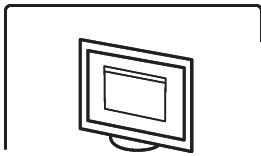

PROBLEM

Local area network / subnet configuration problem

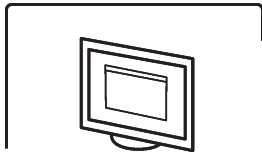
CAUSE / SOLUTION

- i. If the **Dental imaging software** animation (flashing yellow) appears and cable(s) / router(s) are known to be okay ask your network administrator for assistance.

- ii. Conflict / mismatch IP-addresses and / or subnet mask of the unit / PC.
Use command <ipconfig> from the command prompt (**Start >> Run >> cmd** in Windows) to get information about the active network settings.
Change either the IP address of the PC or the unit so that they are both in the same subnet.
If the problem persists ask your network administrator for assistance.

PROBLEM

Ethernet link not active.

The Ethernet connection consists of correctly installed cabling and any switches and/or hubs used, basically the complete Ethernet link

If the link is active it does not necessarily mean that the unit is physically connected to PC. It only means that the unit is physically connected to something that is Ethernet compatible (hub, switch, another PC etc.)

CAUSE / SOLUTION

First remove and then reconnect the Ethernet cable between the unit and PC to see if this solves the problem.

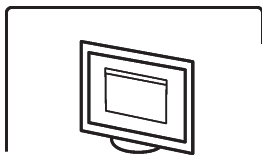

- i. Physical connection is okay (link active), but the the **Dental imaging software** animation (flashing yellow) appears on the unit display. The unit is not configured correctly. Reconfigure.

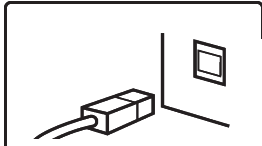

- ii. Cabling not correct (link not active), and the **Unit connection** animation appears on the unit display. The unit is not connected to the PC. Connect the unit to the PC.
- iii. The PC's Ethernet connector(s) is faulty. There is usually a green link LED near the PC's Ethernet connector(s) on the NIC. If the LED is not on, replace the NIC.

PROBLEM

The unit display is not active but the power on / off status light is on, green or yellow.

CAUSE / SOLUTION

- Green LED - defective display or its cabling.
Replace
- Yellow LED - unit is in standby (energy save) mode.